



BMW Wallbox Plus

**INSTRUCTIONS FOR USE.
ORIGINAL BMW ACCESSORIES.**



BMW Wallbox Plus

Instructions for use

Contents

1 Information	4
2 Overview	10
3 Specifications	12
4 Installation	15
5 Electrical installation	20
6 Configuration via the Wallbox Installation App	23
7 Commissioning	25
8 Operation	26
9 Status LED information	38
10 Maintenance	39
11 Technical data	40
12 Disposal	42
13 Country-specific requirements	43

1 Information



Denotes instructions that draw your attention to dangers.



Denotes instructions that draw your attention to special features.

◀ Denotes the end of the instruction or warning text.

1.1 Safety information

Read the safety information carefully and familiarise yourself with the device before you attempt to install, operate or service it.



- Electrical danger! The BMW Wallbox Plus must be installed, commissioned and serviced by appropriate trained, qualified and authorized electricians (1) who bear full responsibility for compliance with current standards and installation regulations.
- Please note that an additional overvoltage protector may be required by vehicles or national regulations. Please refer to your national connection and installation standards.
- Before commissioning the device, check that all screw and terminal connections are tight. The terminal panel must never be left open without supervision. Fit the terminal panel cover when you leave the BMW Wallbox Plus.
- Do not make any unauthorized changes or modifications to the BMW Wallbox Plus.
- Repair work to the BMW Wallbox Plus is not permitted and may only be completed by the manufacturer or a trained expert (BMW Wallbox Plus replacement).
- Do not remove any identifiers such as safety symbols, warning instructions, rating plates, labels or cable markings.
- The BMW Wallbox Plus does not have its own mains switch. The residual current operated circuit breaker and circuit breaker on the building installation is used as a mains isolation device.
- Pull the vehicle connector out of the inlet by the plug, not the cable.
- Ensure that the vehicle connector is not mechanically damaged (kinked, jammed or run over) and that the contact area does not come into contact with heat sources, dirt or water.
- Do not touch the contacts of the connector.
- Always conduct a visual inspection for signs of damage before charging. Pay particular attention to dirt and moisture on the plug, cuts on the vehicle connector cable or chafing on the insulation, and also ensure that the cable output from the BMW Wallbox Plus is securely fastened. ◀

(1) People who, as a result of the training, skills and experience and knowledge of the relevant standards can assess the work and identify possible dangers.



- Never clean the BMW Wallbox Plus using a jet of water (hosepipe, pressure washer, etc.)!
- Ensure that the BMW Wallbox Plus is not damaged by incorrect handling (housing cover, internal parts, etc.).
- If it is raining or snowing and the BMW Wallbox Plus is installed outdoors, do not open the terminal panel cover.
- Do not break the plastic housing by use of excessive force.
- Do not use countersunk screws to secure the device.
- Do not tighten the securing screws with excessive torque, follow the instruction on the torque mentioned in the manual.
- The installation area must be completely flat (max. 1 mm difference between the support and securing points). Do not bend the housing.
- For maximum safety, the smart energy module must be installed/sealed in a secure environment to prevent unauthorised access. All connecting cables and seals must be checked regularly. If a seal is broken, safety can no longer be guaranteed and BMW as well as its affiliated companies are not liable for any damages and/or losses related to such disturbances, security breaches, unauthorised access, interfaces, intrusion, leakage and/or theft of data or information. ◀

Information for trained personnel who may open the device: Danger of damage. Electronic components may be destroyed if touched. Before handling modules, perform an electrical discharge process by touching a metallic grounded object. A failure to follow the safety information may result in a danger of death, injury and damage to the device. The device manufacturer cannot accept any liability for claims resulting from this.

1.2 Intended use

The BMW Wallbox Plus has been developed for use with all BMW Group fully electric and hybrid vehicles and all vehicles which comply with standard IEC61851-1 2017 (with the exception of vehicles with a simplified pilot circuit) or later.

The BMW Wallbox Plus is a charging station for indoor and outdoor use for charging electric or plug-in hybrid vehicles. Do not connect any other devices to it, e.g. electric tools. The BMW Wallbox Plus is designed for installation on a wall or column. You must comply with the relevant national regulations for installing and connecting the BMW Wallbox Plus.

The intended use of the device in every case includes compliance with the ambient conditions for which this device was developed.

The BMW Wallbox Plus was developed, manufactured, tested and documented on the basis of the relevant safety standards. If you comply with the instructions and safety information described for its intended use, the product normally will not pose any danger in terms of property damage or to the health of people.

This device must be grounded. In the event of an error, the ground connection will reduce the danger of an electric shock.

The instructions contained in this manual must be followed to the letter. Otherwise sources of danger may be created or safety equipment may be rendered inoperable. In addition to the safety information provided in this manual, the safety and accident prevention regulations relating to the specific device must be followed.

1.3 About this manual

This manual is designed exclusively for trained personnel. These are people who, as a result of their training, skills and experience and their knowledge of the relevant standards, can assess the work assigned to them and identify possible dangers.

The illustrations and explanations contained in this manual refer to a typical version of the device. Your device version may differ from this.

Please refer to the operating manual for information and instructions for operating the device.

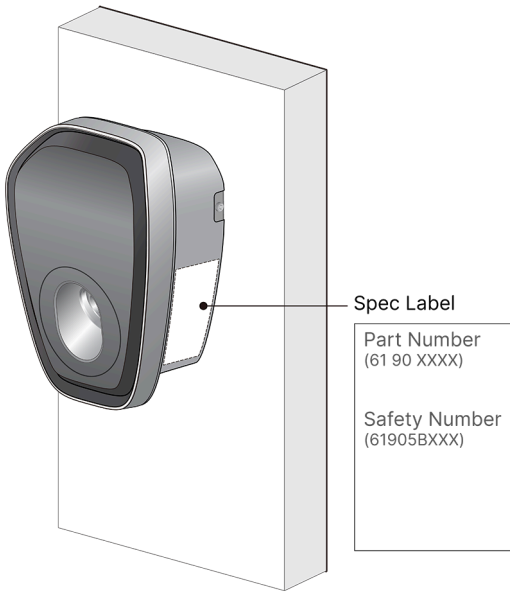
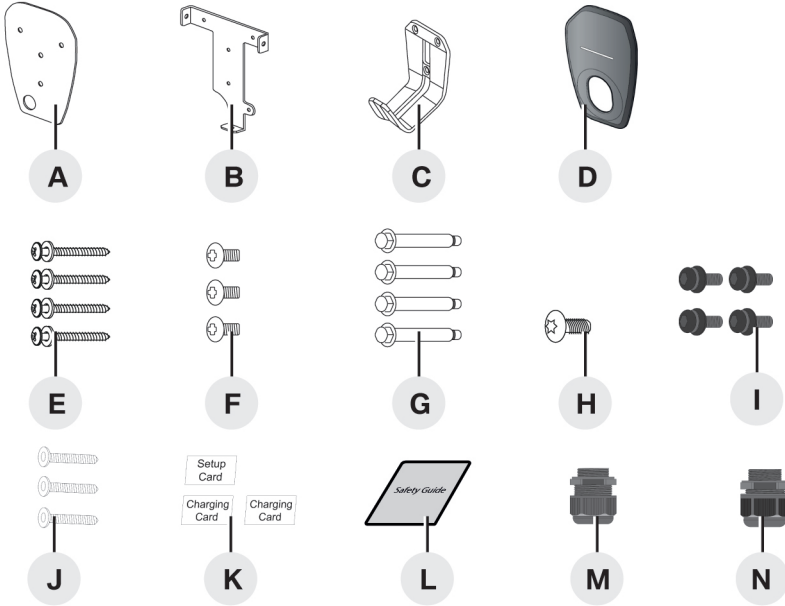

Illustration: Location of specifications label/type plate.

1.4 Package



A Mounting template

B Mounting bracket

C Cable holder

D Cosmetic cover

E No.8 wood screws (4x)

F Torx T30 mounting bolts (3x)

G 1/4" expansion bolts (4x)

H Torx T20 anti-theft screw

I Middle cover screw (4X)

J M6 Hex Socket Cable holder screw (3X)

K Setup Card, Charging Card (2X)

L Safety Guide

M M32 Cable gland

N M25 Cable gland

1.5 Warranty

BMW Service can provide more information on the terms of the warranty. However, the following cases are not covered by the warranty.

- Defects or damage caused by installation work which was not carried out as specified in the BMW Wallbox Plus installation instructions.
- Defects or damage caused by the product not being used as specified in the BMW Wallbox Plus operating manual.
- Costs and damage caused by repair work not carried out by a specialist electrician authorized by a BMW sales outlet or authorized service workshop.

1.6 General information

Connected Home Charging Services (Section 8.6) are available for selected markets. In order to be able to use the load-optimised charging and solar-optimised charging functions, an additional smart energy module is required which must be purchased separately via the installer.

Compatible smart energy modules are listed under Section 5.1.

2 Overview

2.1 Display and controls

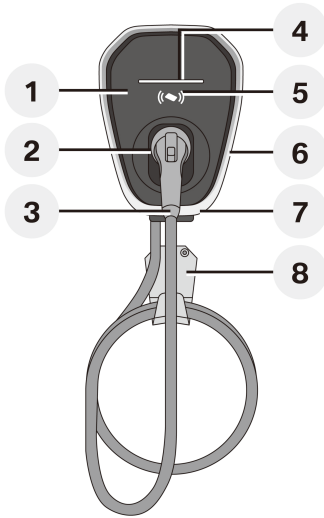

1. Cosmetic cover
2. Vehicle connector inlet
3. Vehicle connector
4. LED indicator
5. RFID Reader
6. Middle cover
7. Mounting bracket
8. Cable holder

2.2 Quick Start Guide for commissioning the BMW Wallbox Plus

1. Downloading and installing the Wallbox Installation App
Scan the following QR code; it can also be found on the Safety Guide and in Section 6 of these operating instructions



Wallbox Installation App for **iOS**



Wallbox Installation App for **Android**

2. Mounting and installing the BMW Wallbox Plus. See Sections 4 to 7 in these operating instructions or the installation instructions in the Wallbox Installation App
3. Optional: Connecting a smart energy module (Section 5.1)
4. Setting up and configuring the BMW Wallbox Plus via the Wallbox Installation App
 - a) Establishing a Bluetooth connection with the Wallbox. Please scan the multifunctional QR code with individual access information on the **password sticker in the Safety Guide** (see Figure 1 below for an example of the QR code)
 - b) Setup and configuration using the Installation Wizard of the Wallbox Installation App
5. Optional: Setting up a back end connection. Required for use with the My BMW App and the Connected Home Charging Packages (for selected markets only)
6. Optional: Activating access control via RFID card (Section 8)
7. Configuration validation and configuration test via the Installation Wizard of the Wallbox Installation App
8. Optional: Establishing the connection to the My BMW App. To establish the connection, please use the multifunctional QR code with individual access information on the **password sticker in the Safety Guide** (see Figure 1 below for an example of the QR code)

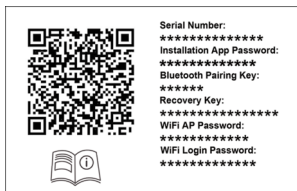

Figure 1: Example of the password sticker in the Safety Guide.

3 Specifications

3.1 General criteria for selecting an installation site

The BMW Wallbox Plus has been designed for indoor and outdoor use. It is therefore necessary to ensure the correct installation conditions and protection for the device at the installation site.

- Take into account the local electrical installation regulations, fire prevention regulations and accident prevention regulations as well as the rescue routes at the site.
- Do not install the BMW Wallbox Plus at locations:
 - Which are used as escape and rescue routes.
 - Which are inside potentially explosive zones.
 - At which the BMW Wallbox Plus is exposed to ammonia or ammonia gases.
 - At which the BMW Wallbox Plus may be damaged by falling objects.
 - At which the BMW Wallbox Plus is on a direct personnel route and people could stumble over the connected vehicle connector.
 - At which the Wallbox Plus may be struck by jets of water.
 - At which the installation surface does not have sufficient strength to withstand the mechanical stresses.
- If possible, install the BMW Wallbox Plus so that it is protected from direct rainfall so as to avoid the effects of weather, icing, damaged by hailstones or the like.
- If possible, install the BMW Wallbox Plus so that it is protected from direct sunlight to prevent the charging current being reduced or the charging process being interrupted as a result of excessive temperatures on components of the BMW Wallbox Plus.
- Comply with the permitted ambient conditions, see section entitled Technical data.
- Ensure compliance with national and international installation standards and regulations.

3.2 Specifications for the electrical connection

Using the Installation Wizard in the Wallbox Installation App, ensure that the maximum current is set in line with the installed circuit breaker.

Selecting the residual-current-operated circuit breaker

The connection cable must be wired into the existing building installation and comply with the national statutory regulations.

The following considerations must be made:

- Every BMW Wallbox Plus must be connected its own residual-current-operated circuit breaker (RCCB) externally. No other circuits may be connected to this RCCB.
- The RCCB must at least be of type A (30 mA trip current).
- Additional measures have been taken in the EVSE to protect it from an alternating current (AC) fault (<30 mA AC) and a direct current (DC) fault (<6 mA DC).

Selecting the circuit breaker

When selecting the circuit breaker, the standard value of the rated conditional residual short-circuit current shall be 1500A for the BMW Wallbox Plus. Also take into consideration the increased ambient temperatures in the control cabinet. In certain circumstances this may require a reduction in the charging current settings to increase the system availability.

Set the rated current to suit the model plate details in conjunction with the required charging power and the supply cable.

A circuit breaker of type B (40 A min., 400 V min.) must be used.

Selecting the supply cable

When selecting the supply cable, take into account the possible reduction factors and the increased ambient temperatures in the internal connection area of the BMW Wallbox Plus, see the temperature rating of the supply terminals. In certain circumstances, this may require an increase in the cable cross-section and an adjustment in the temperature resistance of the supply cable.

Mains isolation device

The BMW Wallbox Plus does not have its own mains switch. The residual-current-operated circuit breaker and/or the circuit breaker in the supply cable are used as a mains isolation device.

4 Installation

4.1 Installation requirements

- Follow the local installation regulations.
- Acclimatization: If there is a temperature difference of more than 15 °C between transport and the installation site, the BMW Wallbox Plus must be acclimatized unopened for at least two hours. Opening the BMW Wallbox Plus immediately may result in condensation formation in the interior and cause damage when the device is switched on. In certain circumstances, damage caused by condensation formation may also not appear until a later date after the installation. Ideally, the BMW Wallbox Plus should be stored for a few hours in advance at the installation site. If this is not possible, the BMW Wallbox Plus should not be stored in low temperatures (< 5 °C) overnight outdoors or in a vehicle.

Tool list

- Electro drill (only for masonry walls)
- Torx T30 screw driver
- Torx T20 screw driver
- Phillips #2 screw driver
- Terminal crimpers
- Cable of appropriate trade size for signal lines, RS-485 (0.75 mm²) M25.
The RS-485 cable must meet the UL2919 requirement.

4.2 Recommended installation positions

When selecting the installation position, taken note of the position of the charge connector on your vehicle and the direction in which you normally park it.

4.3 Required distance

Observe the applicable accessibility requirements for the installation position. The device must be mounted at a sufficient height above ground so that the storage height is between 1,000 mm (39 inches) and 1,200 mm (47 inches).

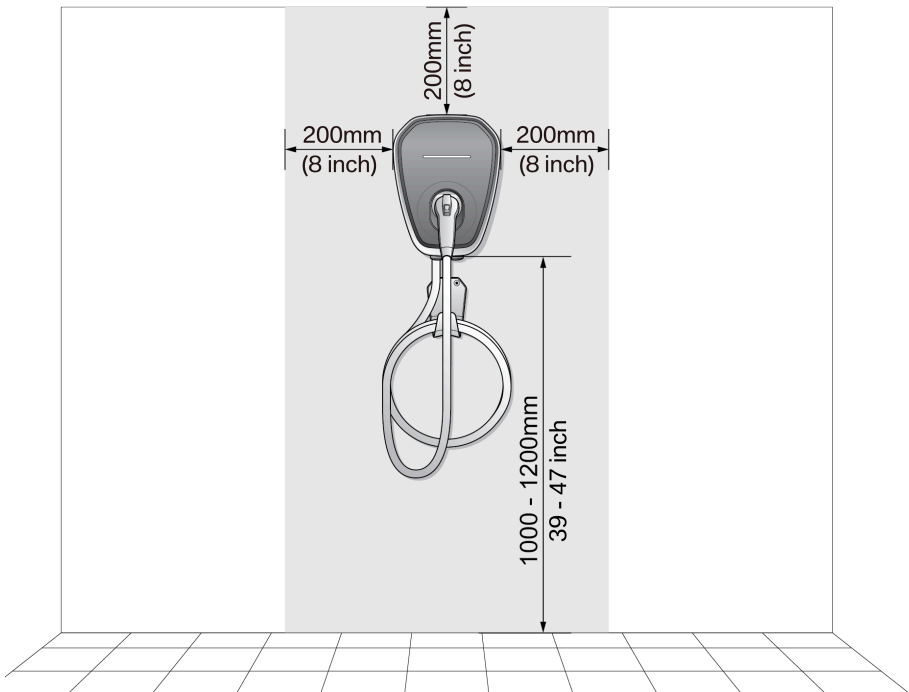

4.4 Mounting the BMW Wallbox Plus

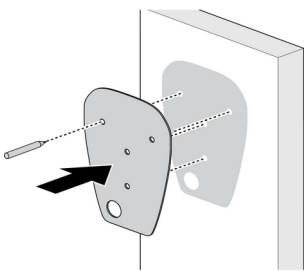
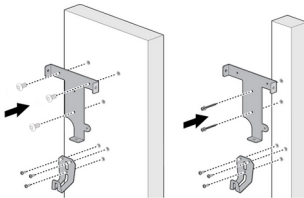
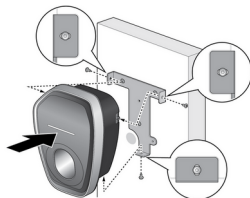
	<p>1. The product is a stationary, wall-mounted device. It includes mounting template A to mark the bolt/screw positions for the mounting bracket and the cable holder (optional).</p>
	<p>2. Fasten mounting bracket B to the wall. The cable holder is optional and depicted in the figure for demonstration purposes.</p> <p>The following bolt/screw types are recommended:</p> <ul style="list-style-type: none">- Masonry walls: 1/4" expansion bolts G Tightening torque: 8.8 Nm (78 lb-in)- Drywalls supported by wooden posts: Wood screws E with a screw length of at least 2" Tightening torque: 3 Nm (26 lb-in)
	<p>3. Align the screw holes on mounting bracket B and the product.</p> <p>4. Install and fasten the product on the mounting bracket B using the supplied Torx T30 F.</p> <p>Tightening torque: 1.5 Nm (13 lb-in)</p>

4.5 Removing the covers

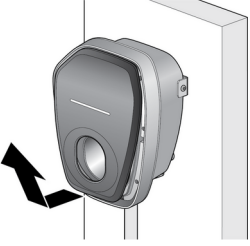
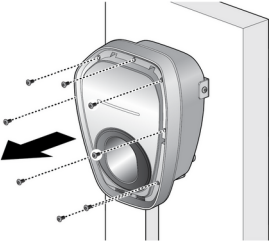
	<p>5. Remove the cosmetic cover D.</p>
	<p>6. Use a T20 screw driver to remove the screws securing the middle cover. Torque: 1.4 Nm (12 lb·in)</p> <p>7. Remove the middle cover.</p> <p>The middle cover has to be removed carefully and held parallel during the process. Do not tilt while removing. Do not remove any other screws apart from the above-mentioned screws.</p>

4.6 Secure the anti-theft screw

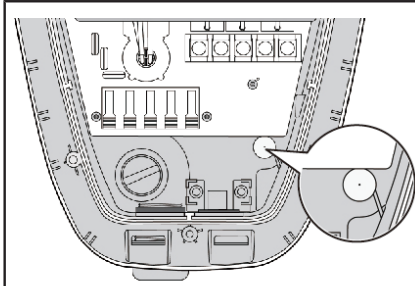

8. The hole for the anti-theft screw **H** is covered by a void label.

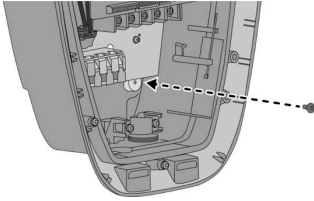

9. Tighten anti-theft screw **H** through the void label.
Tightening torque 1.2 Nm (10 lb in)

5 Electrical installation

Use an appropriate copper wire with listed pressure terminal connectors, such as a ring and fork type, on the end of the conductor before attaching to the terminal blocks. Keep enough wire length to facilitate installation.

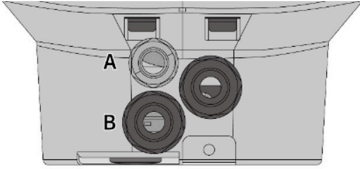
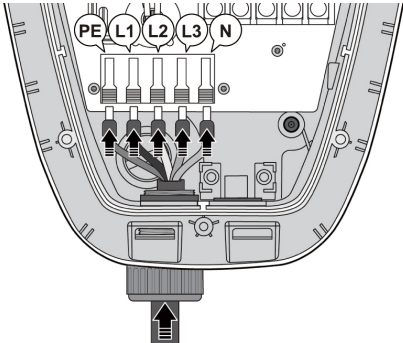
 <p>A</p> <p>B</p>	<p>A Conduit of appropriate trade size for signal wires, RS-485 (0.75mm²). Applicable cable diameter: 9 mm to 11mm</p> <p>B Power input cable. Applicable cable diameter: 13 mm to 20mm</p> <p>C Power outlet cable</p>
 <p>PE L1 L2 L3 N</p> <p>It is also possible to connect the BMW Wallbox Plus to a single phase. To do so, connect terminals L1, N and PE. ◀</p>	<p>Connect each terminal to the correct connector in the terminal input block. Then, secure the terminal for the input cable correctly. The stripped length of the input cable shall follow the indication in the wallbox.</p>
<ul style="list-style-type: none"> ■ Conductor cross section solid max = 16mm² (6 AWG) ■ Conductor cross section flexible with ferrule with plastic sleeve max = 10mm² <p>Choose appropriate conduit in accordance with all applicable local, state and national electrical codes and standards. Make sure the circuit breaker is turned off before installation.</p>	

◀ Ensure that hazardous voltages are isolated safely. ◀

5.1 Optional - connecting a smart energy module

Connect the external smart energy module for monitoring the domestic power connection. The configuration of the smart energy module must be carried out via the Installation Wizard in the Wallbox Installation App. The connection of a smart energy module is required to activate the charging functions of the BMW Connected Home Charging Services (Section 8.6).



You must ensure that the setting parameters of the smart energy module are accurately transferred to the Wallbox Installation App. ◀

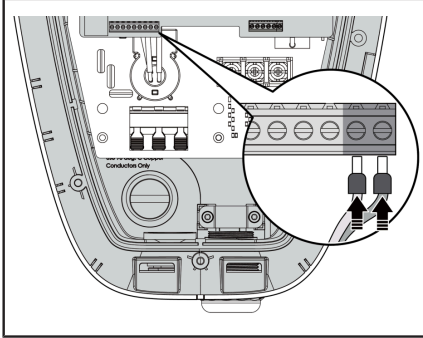

Connect the RS-485 interface with the shielded and twisted connecting cables (>0.5 mm², max. 30 m)
 Definition:
 Pin 8 (CNB12): 485 D+/Tx+/Rx+
 Pin 9 (CNB12): 485 D-/Tx-/Rx-

The following smart energy modules can be used for BMW Connected Home Charging Services – load-optimised charging and solar-optimised charging:

- Inepro Pro 380-MOD for three phase connections
- Inepro Pro2-MOD for single phase connections
- Janitza B23 312-10J for three-phase connections
- Janitza B21 312-10J for single phase connections
- Schneider Electric A9MEM3150
- Siemens 7KT1665

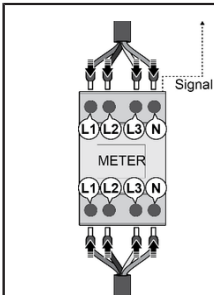

Connect the smart energy module to the power line in accordance with the instructions in the manual of the corresponding smart energy module.

5.2 Optional - peak load distribution

An additional external component is required for peak load distribution and depends on the distribution network operator.

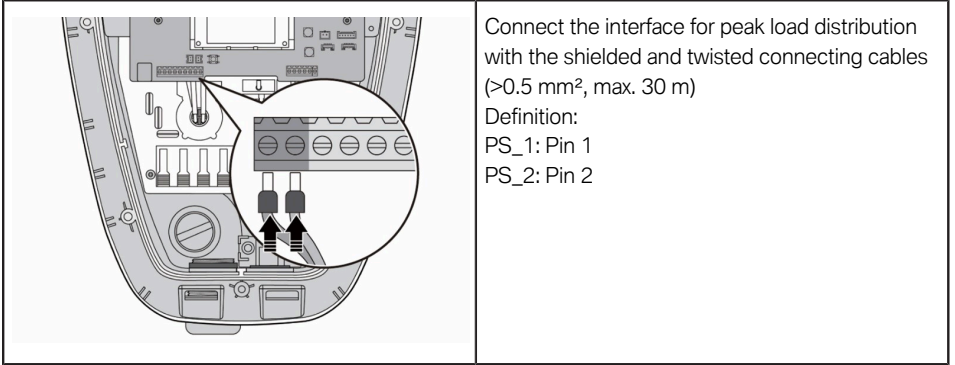

5.3 Optional - Ethernet connection of the Wallbox



In the Wallbox Installation App, the back end connection can also be established via Wi-Fi or eSim. ◀

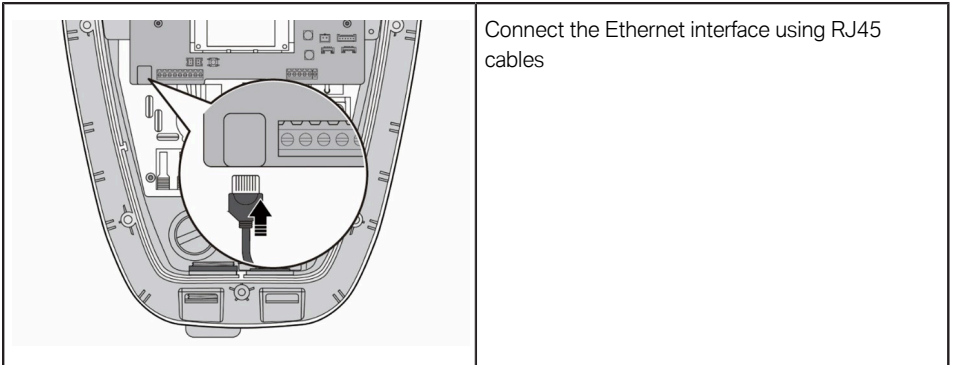

6 Configuration via the Wallbox Installation App

6.1 Wallbox Installation App

You must use the Installation Wizard in the Wallbox Installation App to configure the BMW Wallbox Plus.

If the Installation Wizard has not been completed successfully, charging is not possible.

The installer or BMW service partner must use the Service and Wallbox Installation App to configure the device, download the charging history and diagnosis, update the firmware and rectify errors.

This manual lists all systems and functions that are currently offered. It therefore also describes systems and functions that may not be available at your location due to specific market conditions or the specific installation and configuration.

Some functions may only be accessible via the expert mode in the Wallbox Installation App.

The expert mode is provided for specialists such as qualified electricians to use the Installation Wizard and to change settings related to the mains, smart energy module or back end. The usage of this function is not recommended for general users. The password for accessing expert mode is: **1916**

Features

- Installation Wizard
- Diagnostics Data
- Wallbox Status
- Live data
- Wallbox configuration
- Authorisation settings (RFID)
- RFID card management
- Data connection configuration
- Smart energy module configuration
- Electrical configuration
- Password management of the Wallbox Installation App
- LED indicator brightness
- Installation guide
- Firmware upgrade
- Reset wallbox

The app is available in all relevant app stores.





Wallbox Installation App for iOS

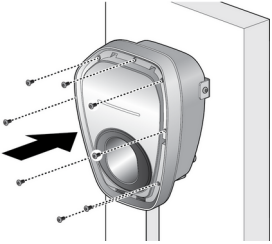
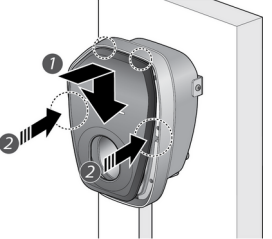

Wallbox Installation App for Android

7 Commissioning

	<p>Install the middle cover. Torque: 1.0 Nm (8.7 lb·in)</p>
	<p>Install and lock the cosmetic cover D.  An audible click sounds denotes a closed faceplate. ◀</p>

 The BMW Wallbox Plus must be connected to the My BMW App. In the My BMW app, go to the “Charging” menu and select “BMW Wallbox”. ◀

8 Operation

The BMW Wallbox Plus is supplied with access control via app deactivated as standard. If you would like to use access control, please adjust the configuration accordingly in the Wallbox Installation App. For further information, see Section 6.

For access control via RFID cards, charging cards must be registered using the setup card. The BMW Wallbox Plus is supplied with two RFID cards.

For access control via automatic vehicle detection (MAC authentication), vehicles must be registered using the setup card. You can use this authentication option with the following vehicles that support ISO 15118.

As of vehicle software 07/24

BMW iX, i7, i5, i4, iX1, iX2

As of vehicle software 03/25

BMW Plug-in Hybrid 2 Series Active Tourer, 3 Series, 5 Series, M5, 7 Series, X1, X3, X5, XM

8.1 Start charging with disabled access control

1. Connect the vehicle connector to vehicle inlet.
2. The vehicle will start the charging session automatically.

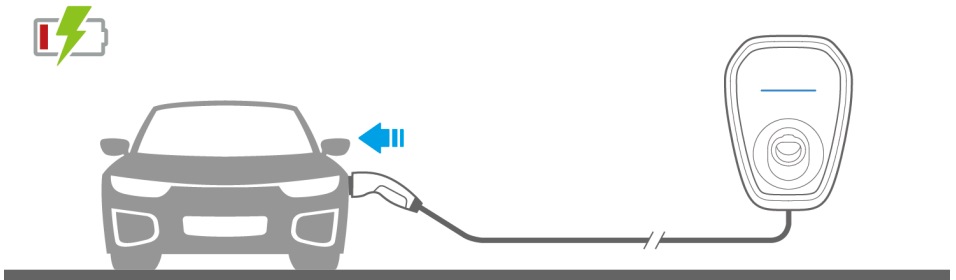

8.2 Stop charging with disabled access control

1. Stop charging session at the vehicle.
2. Disconnect the vehicle connector from the vehicle inlet.
3. Place the vehicle connector back into the vehicle connector inlet of the BMW Wallbox Plus.

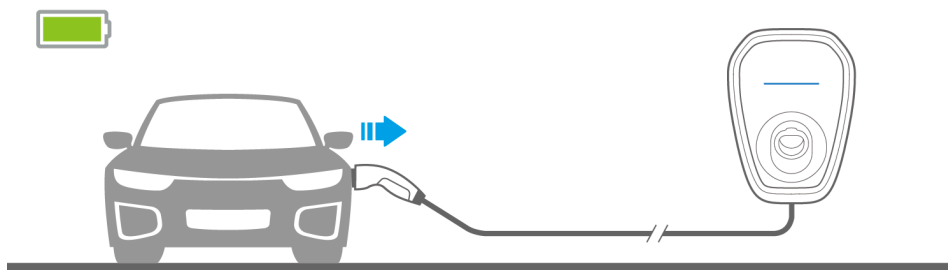

8.3 Starting the charging process with access control via RFID card activated

1. Connect the vehicle connector to vehicle inlet.
2. Hold the RFID card in front of the RFID reader to authorize and initiate the start of the charging session.

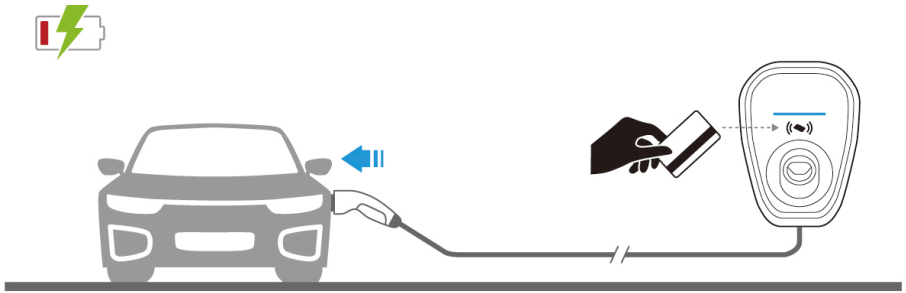

8.4 Terminating the charging process with access control via RFID card activated

1. Stop the charging process at the vehicle, via the My BMW App or the RFID card.
2. Disconnect the vehicle connector from the vehicle inlet.
3. Place the vehicle connector back into the vehicle connector inlet of the BMW Wallbox Plus.

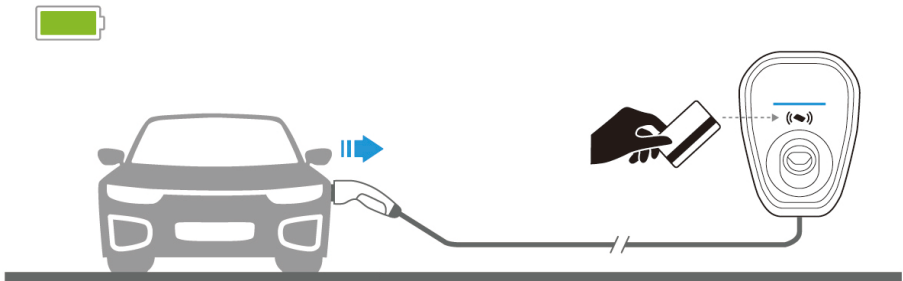

8.5 RFID card registration and registration for access control via automatic vehicle detection (MAC authentication)

The BMW Wallbox Plus Plus uses two different kinds of RFID Cards:

- A Setup Card to notify Wallbox to turn on/off a registration mode
- Charging Cards to control start/stop charging



For more information on how to charge using the charging card, please refer to Section 8.

In addition, you can also register vehicles for access control via automatic vehicle detection (MAC authentication) at the BMW Wallbox Plus. If you use this automatic authentication method for the vehicle, access control via RFID card is no longer necessary.

8.5.1 Registration of new Charging Cards

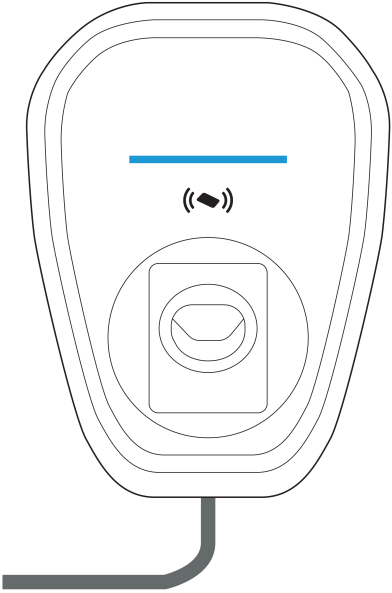
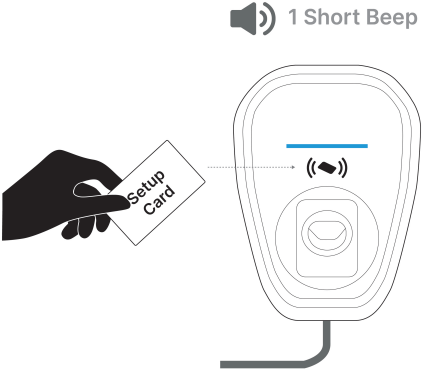

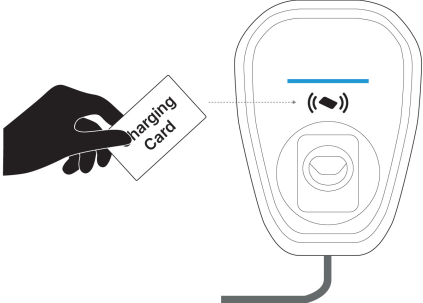
Notice: Additional charging cards must meet the “MIFARE” standard.

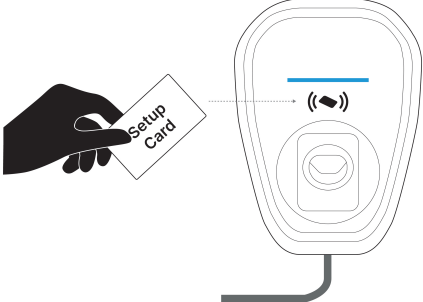
	<p>1. The BMW Wallbox Plus needs to be powered on, DO NOT connect the charging cable with the vehicle. The LED bar should display a steady blue light.</p>
	<p>2. Hold the setup card in front of the RFID reader to start the registration mode for new charging cards. The start of the process is confirmed by a short beep.</p>

<p> 2 Short Beep</p> 	<p>3. Hold the new card in front of the RFID reader to register it at the BMW Wallbox Plus. Registration is confirmed by two short beeps. Repeat this process with any other RFID cards that you want to add.</p>
<p> 1 Long Beep</p> 	<p>4. Hold the setup card in front of the RFID reader to end the registration mode. The end of the process is confirmed by a long beep.</p>

The BMW Wallbox Plus is supplied with a preregistered setup card which can be used to register new charging cards. A new setup card can be registered via the Wallbox Installation App (see Section 6).

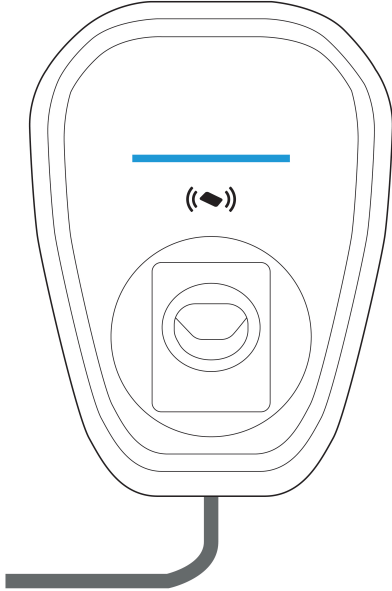
8.5.2 Registering new vehicles for access control via automatic vehicle detection (MAC authentication)

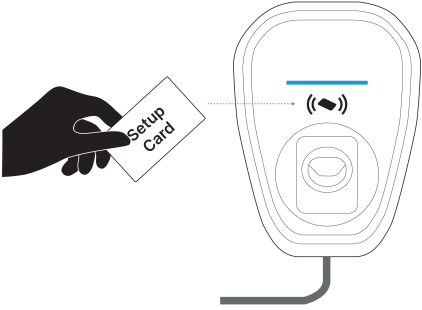
	<p>1. The BMW Wallbox Plus must be switched on. Do NOT connect the charging cable to the vehicle. The LED bar should display a steady blue light.</p>
<p> 1 Short Beep</p> 	<p>2. Hold the setup card in front of the RFID reader to start the registration mode for new vehicles. The process is confirmed by a short beep.</p>

 2 Short Beep

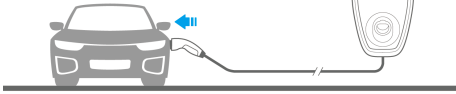

3. Connect the vehicle connector to the vehicle inlet to register the vehicle at the BMW Wallbox Plus. Registration is confirmed by two short acoustic signals. Repeat this process with any other vehicles that you want to add.

 1 Long Beep

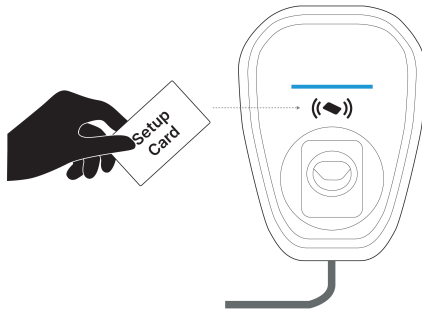

4. Hold the setup card in front of the RFID reader to end the registration mode. The process is confirmed by a long beep.

8.6 Optional – BMW Connected Home Charging Services

Only available for selected markets



This manual lists all systems and functions that are currently offered. It therefore also describes systems and functions that may not be available at your location due to specific market conditions or the specific installation and configuration.

From the moment of activation, the service is included for a market specific term. To ensure continued convenience and seamless usage of the service beyond this initial period, it is necessary to extend the service through the BMW Connected Drive Store.

Requirements: The BMW Connected Home Charging Services can only be used with BMW xEV, a BMW ID account and the My BMW App. In addition, the installation of a smart energy module is required. This is already included in the BMW Connected Home charging package or can be retrofitted individually when purchasing a BMW Wallbox Plus. By monitoring and communicating the current power consumption, the smart energy module enables the holistic optimisation of energy use. For a current list of supported smart energy modules, refer to Section 5.1. ◀

8.6.1 Load-optimized charging

Optimizing the charging power of the BMW Wallbox Plus while taking the household load into account ensures that the total available load at the grid connection point is not exceeded. Dynamic control of load distribution is particularly important in regions with low local grid point capacities.

Load-optimized charging is activated once during installation or configuration and remains permanently as a safety function.

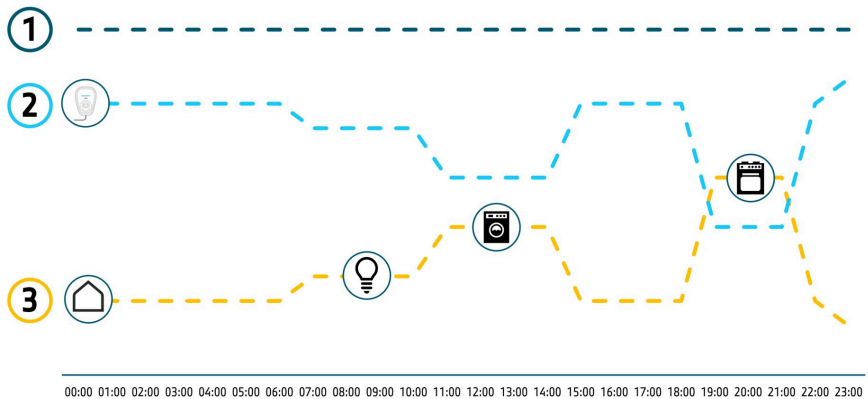

Electrical consumers in the household that might typically be added during the day, such as illumination, or devices used for washing and cooking limit the available charging power. The curve of the BMW Wallbox Plus charging power dynamically adjusts to the remaining consumption in the house, thus preventing an overload at the grid connection point.

8.6.2 Solar-optimized charging

By adjusting the charging speed, the electricity drawn from the grid is minimized and the local self-consumption of the photovoltaic system is maximized. This reduces charging costs and increases the degree of self-sufficiency.

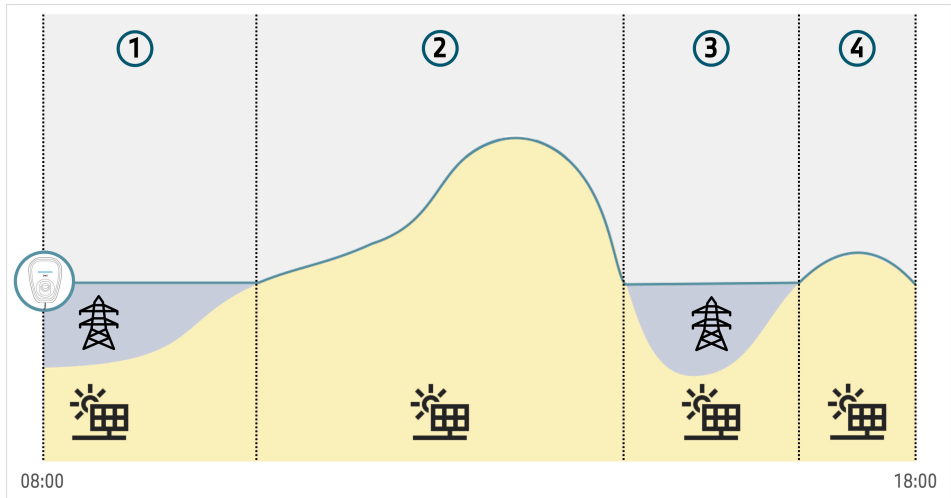

On an exemplary day there are periods with more and less available solar power, resulting in a combined charging power for the BMW Wallbox Plus (displayed by the blue line). When sufficient solar power is available, like in the displayed periods 2 and 4, charging is done exclusively with electricity from the photovoltaic system. The maximum charging power is defined by the total available power. When solar power is not sufficiently available, like in the displayed periods 1 and 3, charging takes place with a combination of solar and grid electricity. To minimize the amount of electricity drawn from the grid, the charging power is intentionally limited during these periods.

With the BMW Connected Home Charging Services, the functional scope of the My BMW app has also been expanded. The app also enables remote management of the Connected Home Charging Services and the BMW Wallbox Plus. In addition, the charging status can be viewed and managed, providing information about the currently charged energy, charging histories, and charging statistics, for example.

9 Status LED information

LED Indicator	Status
Blue, flashing from left to right	BMW Wallbox Plus initialization in progress. BMW Wallbox Plus is suspended temporarily.
Blue	Vehicle is not connected, standby.
Blue, breathing	Vehicle is charging.
Red	Error
Blue (S1/S2/S3), Red (S4)	Communication module is damaged or defective on standby. (The control pilot is in the state A1, A2, B1, B2 or C1)
Blue (S1/S2/S3) breathing, Red (S4)	Communication module is damaged or defective on charging. (The control pilot is in the state C2)
Blue (S1/S2/S3) flashing from left to right, Red (S4)	Communication module is damaged or defective during the firmware update.



10 Maintenance

10.1 Troubleshooting

Situation	Action
LED indicator is not powered.	<ol style="list-style-type: none">1. No supply voltage – check the residual current breaker and power circuit breaker and switch on if necessary.2. Error on the BMW Wallbox Plus – contact your local dealership.
Charging session is not started.	<ol style="list-style-type: none">1. The Vehicle connector has not been inserted correctly – remove the Vehicle connector and reconnect it.2. The vehicle has been programmed to start the charging session at a later point of time.3. The vehicle does not require any energy – check the vehicle status.4. App connection is not working correctly – follow the instructions in the manual.
Vehicle connector cannot be disconnected.	The charging session has not been ended by the vehicle.
LED indicator illuminated in red.	<ol style="list-style-type: none">1. Check the possible causes of the error in the Wallbox Installation App.2. Switch off the supply voltage to the BMW Wallbox Plus using the appropriate mains isolation device.3. Disconnect the vehicle connector and switch on the supply voltage again.4. If the situation persists, contact your local dealership or support.

11 Technical data

Electrical data

Vehicle connector	Type 2 plug
Input/output rating	380–415 V~, 32 A, 50/60 Hz, three phases 110–240 V~, 32 A, 50/60 Hz, single phase
Input wiring	PE, L1, L2, L3, N
Grounding system	TN/ IT/ TT
Rated current (adjustable rated current via Wallbox Installation App)	0A, 6A, 10A, 12A, 16A, 20A, 24A, 32A
Cable length	6 m
Cable feed	Surface-mounted
Minimum connection cross-section	3 x 6mm ²
Internal residual current detection	AC: 15~30mA DC: 3~6mA
Protection against electric shock	Class I
Ingress protection (indoor and outdoor areas)	IP65
Dimensions (W x H x D)	270 x 370 x 185 mm
Weight	6.5kg
Electrical protection	Over current, short circuit, over voltage, under voltage, ground fault, over temperature protection and surge protection, relay welding protection
Encryption	Encryption technology: PSK2/CCMP/SAE Encryption protocol: WPA2/WPA3 Encryption algorithm: AES

Interfaces

Indicator	LED bar indicator
Communication	Bluetooth, RFID, Ethernet, ISO15118, OCPP, 4G, WiFi

Ambient conditions

Operating temperature	-40 °C ~+50 °C
Temperature properties	This is not a safety device, it is just an operating function. The specified operating temperature range must not be exceeded. The device supplies the charging current continuously at the specified operating temperature ranges. When over temperature protection occurred, the EVSE will stop charging. The charging will continue automatically after the EVSE cooling.
Storage temperature	-40 °C to +80 °C
Humidity	95% related humidity, non-condensing
Altitude	3000 m
Cooling	Natural cooling
Impact protection	IK09
Overvoltage category	OVC III
Cold load pick-up	Randomized delay between 1 and 120 seconds before charging restart after power outage



The available charging capacity is depending on the vehicle, the infrastructure and general settings. ◀



Extension cables must not be used. ◀

12 Disposal



After correctly decommissioning the device, please have it disposed of by the service department in compliance with current waste disposal regulations.

The electrical and electronic devices including accessories must be disposed of separately from general household waste. There are instructions on the product, in the instructions for use or on the packaging.

The materials can be recycled as shown by their labelling. You can make a significant contribution to protecting our environment by reusing, recycling the material or other forms of recycling of end-of-life devices.

13 Country-specific requirements

For Brazil

“Este produto está homologado pela ANATEL, de acordo com os procedimentos regulamentados pela Resolução nº 680, e atende aos requisitos técnicos aplicados”

Para maiores informações, consulte o site da ANATEL

www.anatel.gov.br



Este equipamento não tem direito à proteção contra interferência prejudicial e não pode causar interferência em sistemas devidamente autorizados.

Este equipamento não tem direito à proteção contra interferência prejudicial e não pode causar interferência em sistemas devidamente autorizados. Para maiores informações, consulte o site da ANATEL – www.anatel.gov.br

Incorpora produto homologado pela ANATEL sob número 01979-21-05015, 19085-21-02725.

For Brazil

Informações sobre cibersegurança

Coleta de dados e atualização do Seciruty:

Os dados pessoais serão coletados, utilizados e armazenados, sejam sensíveis ou não. Este produto garante que as atualizações de segurança serão fornecidas por 2 anos após o lançamento do produto ou por dois anos quando o dispositivo for distribuído para o mercado consumidor.

Canal de comunicação

Verifique aqui https://www.deltawww.com/en-US/Cybersecurity_Advisory relatar vulnerabilidades de segurança identificadas em produtos. Aqui podem encontrar informações abaixo:

- a) Informar sobre novas vulnerabilidades identificadas em seus produtos, medidas de mitigação e patches de segurança associados.
- b) Mantenha um histórico de: vulnerabilidades identificadas, medidas de mitigação e patches de segurança.
- c) Permitir o acesso a patches de segurança e/ou novas versões de software/firmware para seus produtos.
- d) Fornecer manuais e outros materiais com orientações quanto à configuração, atualização e uso seguros dos equipamentos.

1. Технічні характеристики радіоблданнтя:

1.1 GSM-900:

Діапазони частот, МГц:

передавача: 880,1 - 915,0;

приймача: 925,1 - 960,0;

Потужність передавача, Вт: 2,07;

Класи випромінювання: 200KF7W, 200KG7W;

Тип антени: неаправлена, інтегрована.

1.2 GSM-1800:

Діапазони частот, МГц:

передавача: 1710,0 - 1785,0;

приймача: 1805,0 - 1880,0;

Потужність передавача, 0,90;

Класи випромінювання: 200KF7W, 200KG7W;

Тип антени: неаправлена, інтегрована.

1.3 UMTS Band VIII:

Діапазони частот, МГц:

передавача: 888,8 - 906,0;

приймача: 933,8 - 951,0;

Потужність передавача, Вт: 0,21;

Класи випромінювання: 5M00G7W, 5M00D7W;

Тип антени: неаправлена, інтегрована.

1.4 UMTS Band I:

Діапазони частот, МГц:

передавача: 1920,0 - 1980,0;

приймача: 2110,0 - 2170,0;

Потужність передавача, Вт: 0,22;

Класи випромінювання: 5M00G7W, 5M00D7W;

Тип антени: неаправлена, інтегрована.

For Ukraine

1.5 LTE-800 (E-UTRA Band 20):

Діапазони частот, МГц:

передавача: 832,0 - 842,0;

приймача: 791,0 - 801,0;

Потужність передавача, Вт: 0,25;

Класи випромінювання: 5M00G7W, 5M00D7W, 10M0G7W, 10M0D7W;

Тип антени: ненаправлена, інтегрована.

1.6 LTE-900 (E-UTRA Band 8):

Діапазони частот, МГц:

передавача: 888,8 - 906,0;

приймача: 933,8 - 951,0;

Потужність передавача, Вт: 0,21;

Класи випромінювання: 1M40G7W, 1M40D7W, 3M00G7W, 3M00D7W, 5M00G7W, 5M00D7W, 10M0G7W, 10M0D7W;

Тип антени: ненаправлена, інтегрована.

1.7 LTE-2600 (E-UTRA Band 7):

Діапазони частот, МГц:

передавача: 2510,0 - 2545,0 ; 2565,0 - 2570,0;

приймача: 2630,0 - 2665,0; 2685,0 - 2690,0;

Потужність передавача, Вт: 0,20;

Класи випромінювання: 5M00G7W, 5M00D7W, 10M0G7W, 10M0D7W, 15M0G7W, 15M0D7W, 20M0G7W, 20M0D7W;

Тип антени: ненаправлена, інтегрована.

1.8 LTE-1800 (E-UTRA Band 3):

Діапазони частот, МГц:

передавача: 1710,0 - 1785,0;

приймача: 1805,0 - 1880,0;

Потужність передавача, Вт: 0,23;

Класи випромінювання: 1M40G7W, 1M40D7W, 3M00G7W, 3M00D7W, 5M00G7W, 5M00D7W, 10M0G7W, 10M0D7W, 15M0G7W, 15M0D7W, 20M0G7W, 20M0D7W;

Тип антени: ненаправлена, інтегрована.

For Ukraine

1.9 Wi-Fi (IEEE 802.11 a/b/g/n/ac/ax):

Діапазони частот, МГц:

- IEEE 802.11 b/g/n/ax : 2400,0 - 2483,5;

- IEEE 802.11 a/n/ac/ax : 5150,0 - 5350,0; 5470,0 - 5725,0; 5725,0 - 5850,0;

Максимальна вихідна потужність передавача, мВт (дБм):

- IEEE 802.11 b/g/n/ax: 55,21 (17,42);

- IEEE 802.11 a/n/ac/ax: 31,62 (15,30);

Класи випромінювання: 20M0G1W, 20M0D1W 40M0G1W, 40M0D1W, 80M0G1W, 80M0D1W;

Коефіцієнт підсилення, дБі: 2,8 (IEEE 802.11 b/g/n/ax), 4,7 (IEEE 802.11 a/n/ac/ax);

ЕІВП, не більше, мВт (дБм): 100 (20) (IEEE 802.11 b/g/n/ax), 200 (23) (IEEE 802.11 a/n/ac/ax);

Тип антени: неуправлена, інтегрована.

1.10 Bluetooth (IEEE 802.15):

Діапазон частот, МГц: 2400,0 - 2483,5;

Максимальна вихідна потужність передавача, мВт (дБм): 1,32 (1,21);

Класи випромінювання: 2M00FXW;

Коефіцієнт підсилення, дБі: 0,5;

ЕІВП, не більше, мВт (дБм): 100 (20);

Тип антени: неуправлена, інтегрована.

1.11 Пристрій радіочастотної ідентифікації RFID:

Діапазон частот, МГц: 13,56;

Максимальна напруженість магнітного поля передавача, на відстані 10 м, дБмкА/м: мінус 25,78;

Клас випромінювання: 14K0A1D.





RACCOLTA CARTA
Verifica le disposizioni
del tuo Comune.

EAC

